





DATA SHEET

Oxygen Sensing—LuminOx ppm Sensor *Luminescence-based Optical Flow-Through Series*

FEATURES

- Operates in any O₂ concentration without damaging the sensor
- Long life, non-depleting technology—no need to store in an inert gas environment
- Fast response and purge times
- Connects directly to a microcontroller without any additional circuitry
- Factory calibrated
- Low power—high accuracy—fast response



<p>Housing</p>  <p>COMPACT</p>	<p>Supply Voltage</p>  <p>4.5 - 5.5 V VOLTAGE</p>	<p>Operating Temp</p>  <p>-10°C to +35°C TEMPERATURE</p>	<p>Output Digital</p>  <p>TTL Modbus RTU</p>	<p>Response Time</p>  <p>< 30 secs</p>
---	--	---	--	--

BENEFITS

- Compact footprint, flow-through housing with sealed base
- Evaluation kit available with Windows software and USB to UART converter cable
- Contains no hazardous materials; RoHS & REACH compliant

OUTPUT VALUES^a

Oxygen range	0—1000 ppm
Oxygen pressure range	0—1.2 mbar ppO ₂
Response time ^b	T90 < 30 seconds (typical)
Purge time	≥ 30 minutes
Accuracy	
ppO ₂	< 2 % full scale
Temperature	Indication only
Pressure	± 5 mbar
O ₂	Determined by ppO ₂ & pressure accuracy
Resolution	
ppO ₂	0.001 mbar
Temperature	0.1 °C
Pressure	1 mbar
O ₂	1 ppm

Other sensor options available on request, email: technical@sstsensing.com

TECHNICAL SPECIFICATIONS

Supply voltage (Vs)	4.5—5.5 V _{DC}
Supply current (Is)	< 30 mA Average < 60 mA Peak
Output Type	3.3 V TTL level UART (Modbus RTU)
Temperature	
Operating:	-10 °C to +35 °C
Storage:	-30 °C to +35 °C
Humidity	Dry, clean gas
Barometric pressure range	500—1200 mbar
Flow rate	0.5 litre / minute minimum 1.0 litre / minute maximum

Need help? Ask the expert
Tel: + 44 (0)1236 459 020
and ask for “Technical”



NOTES

- At ambient conditions. All performance measurements are at STP unless otherwise stated. Following extreme temperature fluctuations, re-calibration may be required.
- Refer to response time graph on page 2.

RESPONSE TIME GRAPH

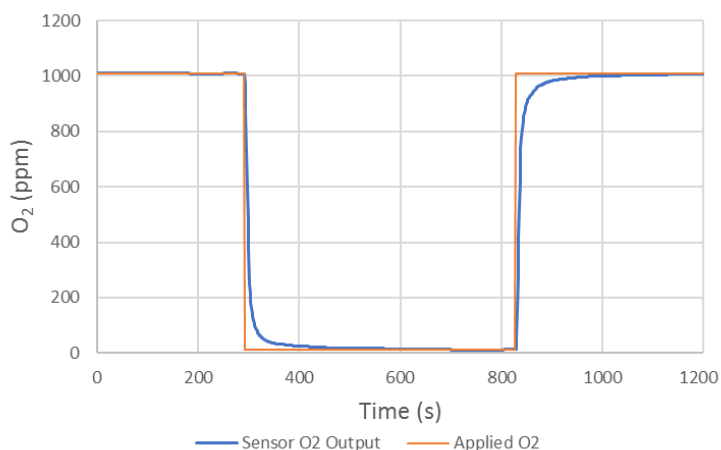

NOTE: Graph shown reflects the following conditions:
Switching between 1010 ppm and 10 ppm with a flow rate of 1 litre/ min at 20 °C.

ELECTRICAL INTERFACE

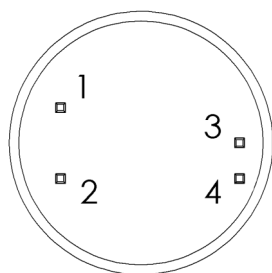

Pin	Designation
1	Vs (+ 5 V)
2	GND (0 V)
3	3.3 V UART Sensor Transmit
4	3.3 V UART Sensor Receive

CONNECTION: Four gold-plated pins (0.64 mm²) on a 2.54 mm grid for PCB mounting via sockets or hand soldering using no-clean flux.

NOTE: Do NOT put the sensor through a PCB washing process.

NOTE: Always apply power to sensor pins 1 and 2 before attempting to communicate on pins 3 and 4.



The sensor should be treated as an electronic component and handled using the correct ESD handling precautions.

OUTLINE DRAWING

All dimensions shown in mm. Tolerances = ± 0.5 mm.

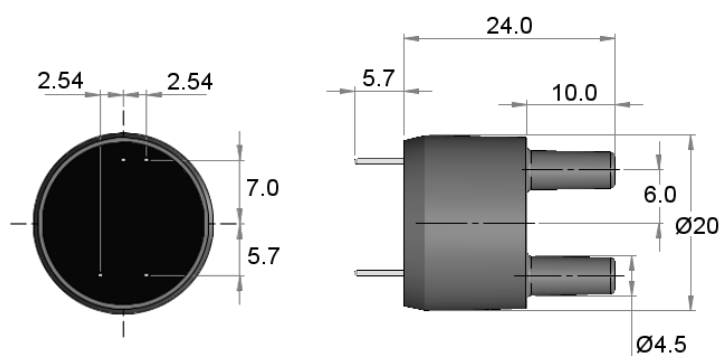

NOTE: 4.5 mm OD push-fit tubing connectors.

ORDER INFORMATION

When ordering, specify part number:

L O X - P P M - 1 0 0 0 - F

The sensor is also available as part of an evaluation kit. The evaluation kit includes a LuminOx ppm sensor, USB to UART converter cable and Windows evaluation & logging software.

Contact sales@sstsensing.com for details.

CAUTION

Do not exceed maximum ratings and ensure sensor(s) are operated in accordance with their requirements. Carefully follow all wiring instructions. Incorrect wiring can cause permanent damage to the device. Do NOT use chemical cleaning agents.

Failure to comply with these instructions may result in product damage.

INFORMATION

As customer applications are outside of SST Sensing Ltd.'s control, the information provided is given without legal responsibility. Customers should test under their own conditions to ensure that the equipment is suitable for their intended application.

For technical assistance or advice, please email: technical@sstsensing.com

General Note: SST Sensing Ltd. reserves the right to make changes to product specifications without notice or liability. All information is subject to SST Sensing Ltd.'s own data and considered accurate at time of going to print.